

**STEEL BUILDING MATERIALS
FLOOR DECK SYSTEM
CATALOGUE**

www.ecosteel.com

TABLE OF CONTENT



01. Who are we03
02. Our Story04-05
03. Product Overview06-07
04. Product Series introduction08-09
05. Open type floor deck10-12
06. Steel Truss Deck13-14
07. Order Process15
08. Why choose us16

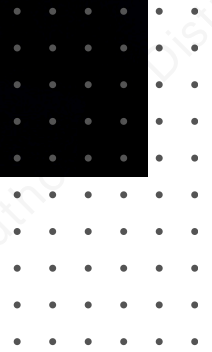

WHO ARE WE

Ecosteel Source is a professional supplier of steel materials, offering Zinc-Aluminum-Magnesium (Z-A-M) coated steel, Galvalume (GL), pre-painted steel coils, and steel construction product made from that like Floor Decks, Steel Truss Floor Deck, Sandwich Panels (Hand-made & Machine-made), C/Z/U purlins, steel Studs, Tracks & Furring Channels, and Steel Accessories like Steel Strapping Seal.

With advanced processing equipment and strict quality control, we deliver durable, eco-friendly, and customized solutions for construction, industrial facilities, infrastructure, and cleanroom systems.

OUR STORY

Rooted in Nature. Committed to the Future.

Ecosteel Source was founded in Sichuan, a region known not only for its emerging industrial base, but also as the native home of the giant panda – a global symbol of ecological harmony. Inspired by this unique environment, we are deeply aware of the responsibility to balance industrial progress with environmental sustainability.

In today's fast-evolving steel industry, we believe that strength and sustainability should go hand in hand. Drawing from the panda's symbolism of balance and resilience, Ecosteel is committed to delivering steel solutions that combine durability with environmental responsibility.

Born in Sichuan – a place of strength and serenity – we carry the spirit of the giant panda into everything we build.



OUR STORY

Inspired by the panda. Built for a greener world.

As both a materials supplier and a finished product manufacturer, we serve a wide range of industries — from industrial construction and cold chain logistics, to coastal projects and cleanroom environments. Whether it's floor decking, roofing panels, or structural components, we aim to reduce maintenance, extend service life, and minimize the carbon footprint of every building.

Our mission is to bring harmony between industry and ecology.

With every coil, panel, or beam we deliver, we take a step toward a greener construction future.

When you choose Ecosteel, you are not only choosing reliable steel products —

you are choosing a future where performance and sustainability work together.

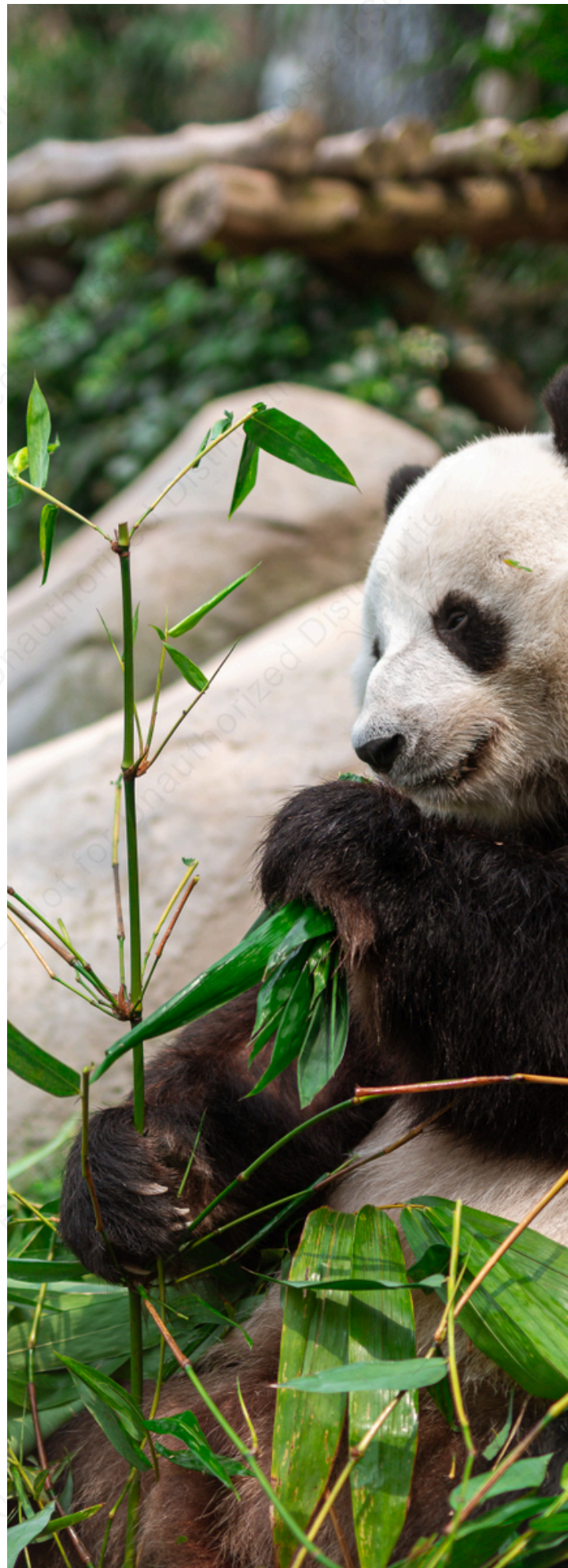



PRODUCT OVERVIEW

- Steel Building Materials:** Floor Deck System; Roofing & Wall Panels; Metal Studs & Purlins
- Coils & Sheets:** Galvanized Steel (GI); Galvalume Steel (GL); Zinc-Aluminum-Magnesium (Z-A-M) coated steel, Pre-painted color coated steel (PPGI, PPGL)
- Steel Accessories:** Steel Strapping Seal



PRODUCT OVERVIEW

STEEL BUILDING MATERIALS

- Floor Deck System:** Open type floor deck; Steel Truss Deck
- Roofing & Wall Panels:** Color coated steel sheets(also called Metal Roofing Sheet or Metal Wall Cladding Panel); sandwich panels, handmade cleanroom panels
- Metal Studs & Purlins:** C/Z/U purlins; Steel stud, track & furring channels

PRODUCT SERIES

FROM **PREMIUM** TO **VALUE** — TAILORED FOR EVERY PROJECT

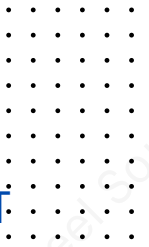

 **ES Prime Series**
Premium · Innovative · Exceptional



 **ES Standard Series: Balanced · Versatile · Durable**



 **ES Value Series: Affordable · Practical · Reliable**

HOW TO CHOOSE?

At Ecosteel Source, every series delivers the same reliable foundation—what sets them apart is the **material grade** and **performance level**.

- **Unified Standards:** All series follow the same specifications in size, thickness, and structure.
- **Tailored Performance:** Differences lie in the raw materials and durability enhancements.
- **Worry-Free Choice:** Select the series that matches your budget and project goals with full compatibility assurance.

PRODUCT SERIES

FROM **PREMIUM** TO **VALUE** — TAILORED FOR EVERY PROJECT

ES Prime - Flagship Performance

- Top-tier quality
- Advanced coatings
- Extended lifespan
- Premium applications

Typical materials: High-grade ZAM steel (Zinc-Aluminum-Magnesium), premium Galvalume (like AZ120, AZ150), High zinc coat Galvanized steel (GI) (from 150 to 900g/m²), fluorocarbon (PVDF) coated steel etc.

ES Standard - Balanced Reliability

- Solid performance
- Good corrosion resistance
- Cost-performance balance
- Versatile use

Typical materials: Galvanized steel (GI) (Zinc 60g-120g/m²), Galvalume (GL)(less than AZ120), basic ZAM steel, HDP&SMP Pre-painted Steel etc.

ES Value - Smart Affordability

- Economical solution
- Essential quality
- Simplified specs
- Budget-focused use

Typical materials: Basic Galvanized steel (GI) (Zinc 30g-60g/m²), economical PE Pre-painted Steel etc.

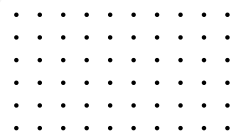

FLOOR DECK SYSTEM

Open type floor deck (or Corrugated steel floor deck)

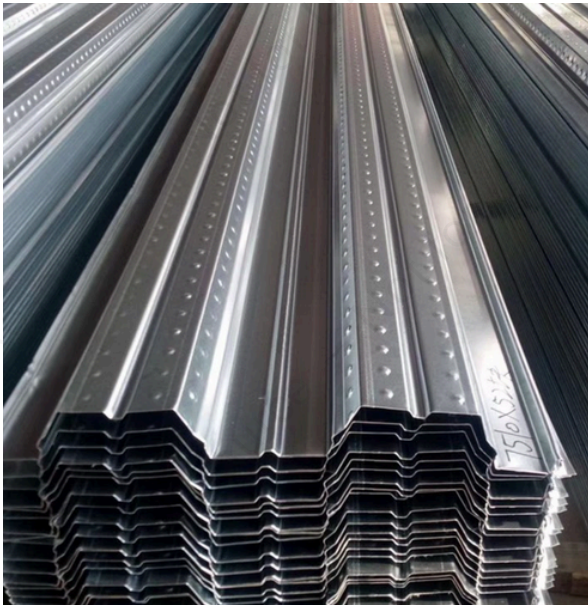

Features	Specification
Zinc coating	40g/m ² -900g/m ²
Steel sheet material	Q235,Q345 or customize
Width	depends on models
Steel sheet thickness	0.27mm-2.0mm or customize
Height	35mm-76mm
Standard	AISI,ASTM,BS,DIN,GB,JIS

FLOOR DECK SYSTEM

Open type floor deck (or Corrugated steel floor deck)

Product Model:

YX75-200-600, YX76-344-688, YX75-230-690, YX51-240-720, YX35-125-750, YX51-253-760, YX28-205-820, YX51-305-915, YX51-342-1025, YX40-200

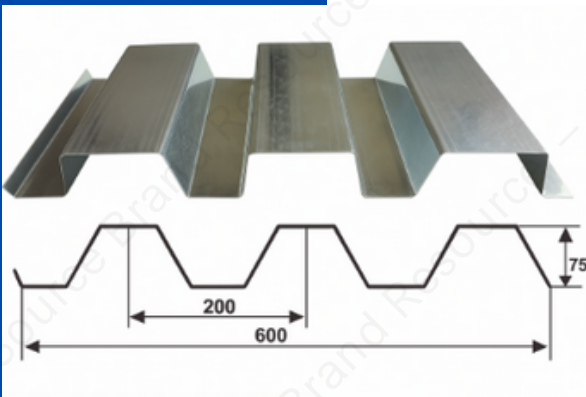

YX75-200-600

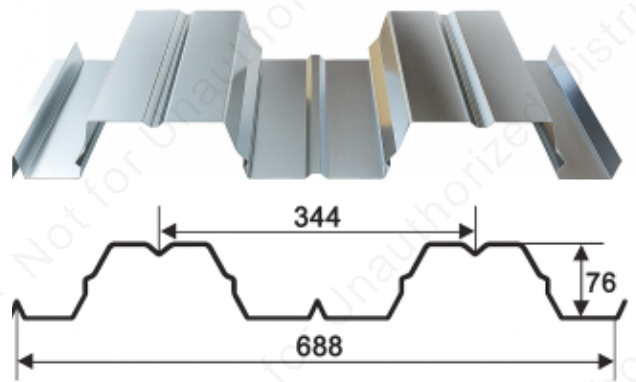

YX76-344-688

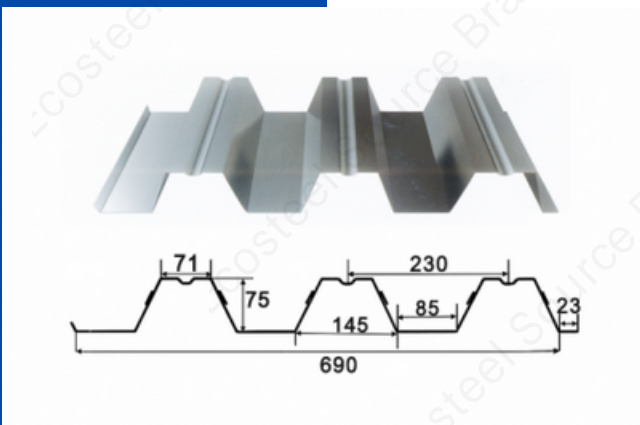

YX75-230-690

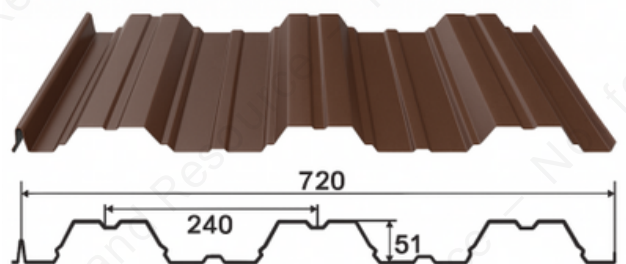

YX51-240-720

FLOOR DECK SYSTEM

Open type floor deck (or Corrugated steel floor deck)

Product Model:

YX75-200-600, YX76-344-688, YX75-230-690, YX51-240-720, YX35-125-750, YX51-253-760, YX28-205-820, YX51-305-915, YX51-342-1025, YX40-200

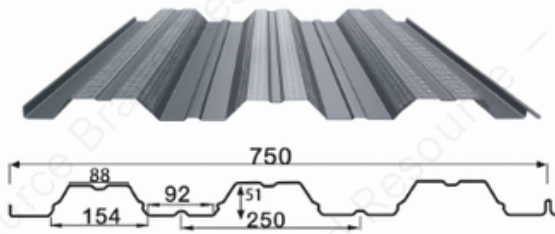

YX35-125-750

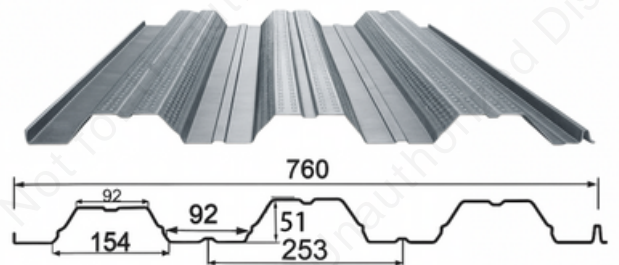

YX51-253-760

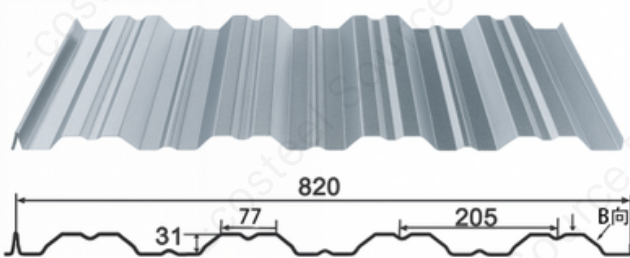

YX31-205-820

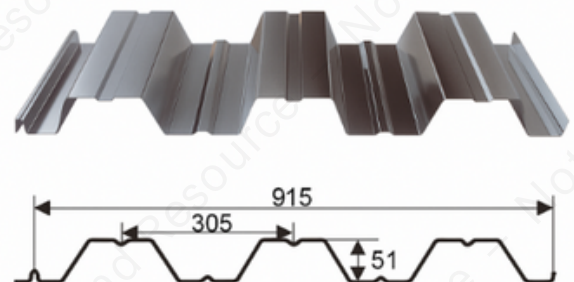

YX51-305-915

FLOOR DECK SYSTEM

Open type floor deck (or Corrugated steel floor deck)

Product Model:

YX75-200-600, YX76-344-688, YX75-230-690, YX51-240-720, YX35-125-750, YX51-253-760, YX28-205-820, YX51-305-915, YX51-342-1025, YX40-200

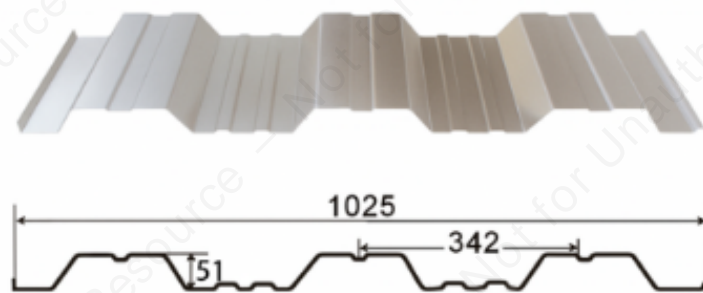

YX51-342-1025

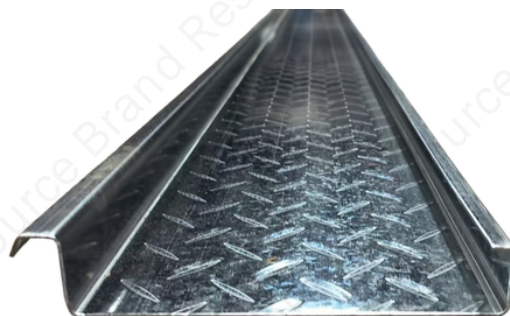
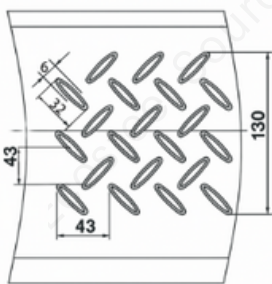

YX40-200

Cast-in-place-free :

It does not require laying steel bars or pouring concrete.

FLOOR DECK SYSTEM

Steel Truss Deck

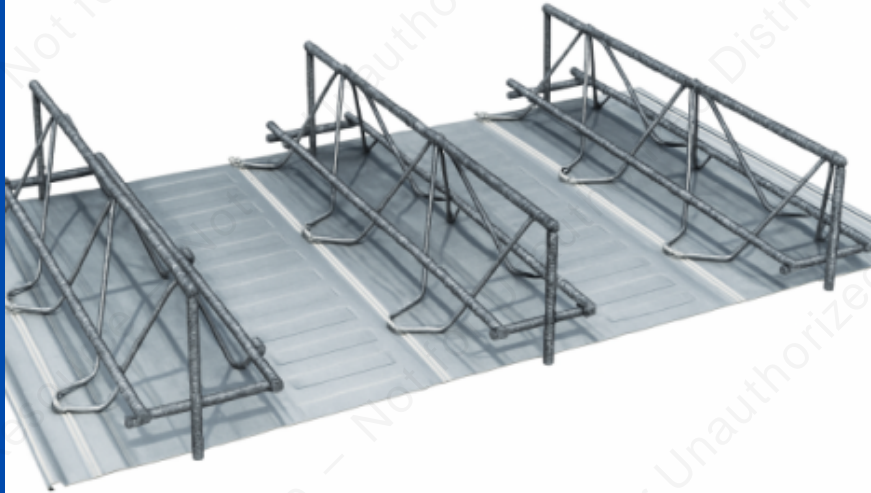

Features	Specification
Zinc coating	80g/m ² -275g/m ²
Steel sheet material	Q235,Q345 or customize
Width	576mm/600mm
Steel sheet thickness	0.4mm,0.5mm,0.6mm or customize
Height	70mm-270mm
Top and bottom bar diameter	6mm-12mm
Distributing bar diameter	4mm-10mm
Standard	AISI,ASTM,BS,DIN,GB,JIS

FLOOR DECK SYSTEM

Steel Truss Deck Product model: 576 and 600

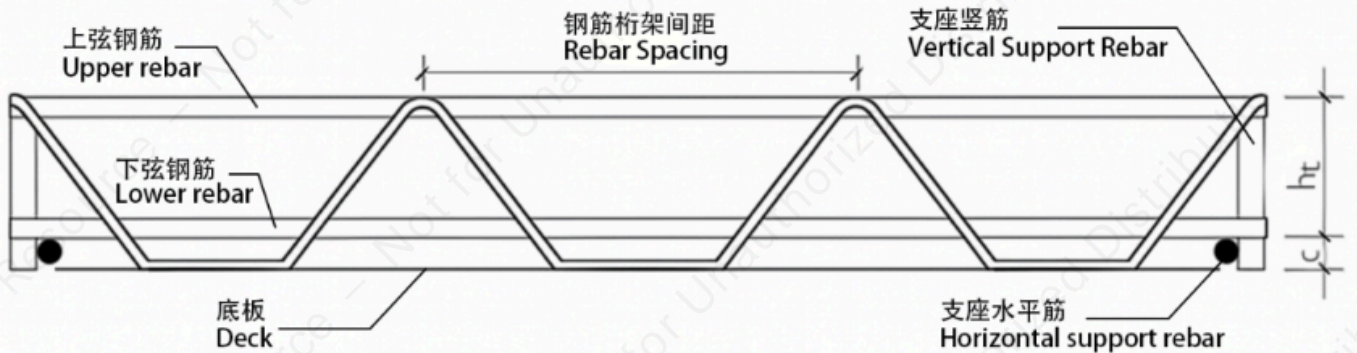

Structural Diagram

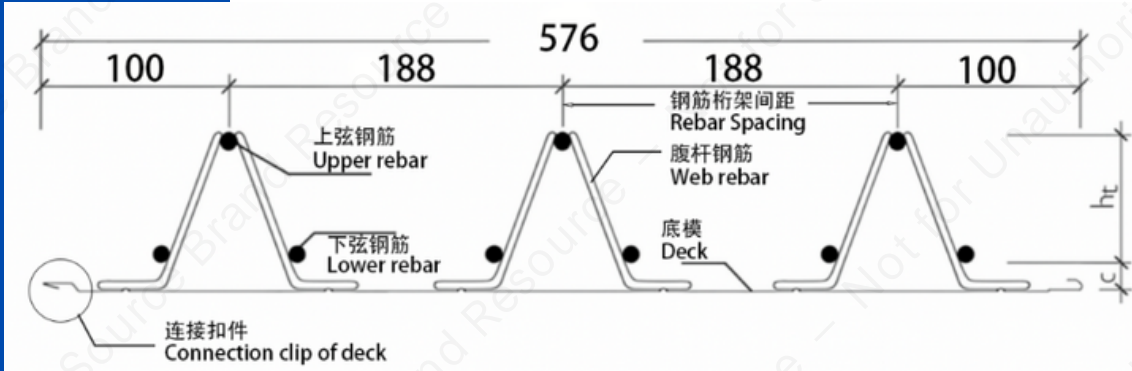



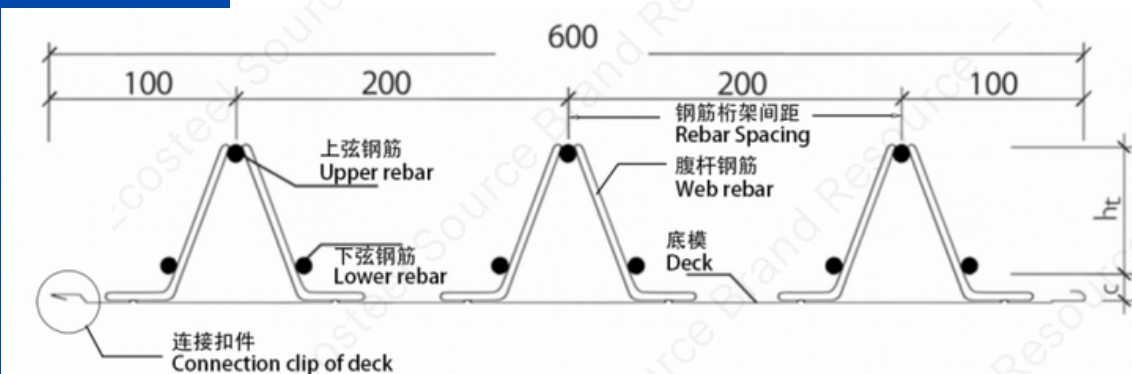





576 MODEL











600 MODEL

EASY STEPS TO ORDER

Order Process

 Inquiry →  Quotation →  Sample → 
Contract & Payments →  Production →  Packing & Balance →  Shipment & Documents →  After-sales

-  **Inquiry** : Provide product specifications (material, size, coating, color, quantity, application).
-  **Quotation** : Get formal quotation with price, lead time, payment, and other details.
-  **Sample & Drawing** : Confirm samples or drawings for customized colors/patterns.
-  **Contract & Payments** : Sign PI/contract and pay deposit to schedule production; Special customized products require full payment in advance.
-  **Production & QC** : Manufacturing with strict quality control, third-party inspection available.
-  **Packing & Balance** : Packed to international standards, and settle balance payment.
-  **Shipment & Documents** : shipment arranged with documents, receive full set of shipping documents.
-  **After-sales** : Technical support, long-term supply and project services.

WHY CHOOSE US

Uncompromising Quality

Strict quality control and testing ensure durability, corrosion resistance, and consistency.

Tailored Solutions

Customized sizes, coatings, and finishes to meet unique project needs.

Competitive Value

Advanced manufacturing and efficient supply chain deliver cost-effective solutions.

Sustainable Commitment

Eco-friendly production and long life cycles support greener construction.

Global Support

Reliable logistics and professional support ensure timely delivery worldwide.





76 Bazhen Aveue, Chengdu, Sichuan, China
info@ecosteelsource.com
www.ecosteelsource.com